

FTB CONNECT - Fiber termination box for wall and pole mounting with access protection

- 1x adapter-holder with 13 SC adapters (or 26x LC)
- 6x fiber trays
- Each fiber tray holds 12x crimp/shrink splices and 2x PLC
- 10 access ports (4 bottom, 2 each side and 2 on top)
- Prepared for sealing wire
- 2x additional strain relief clamps for aramid
- Rubber grommets for 3mm-12mm fibers
- Optimized for 2 mm patchcords

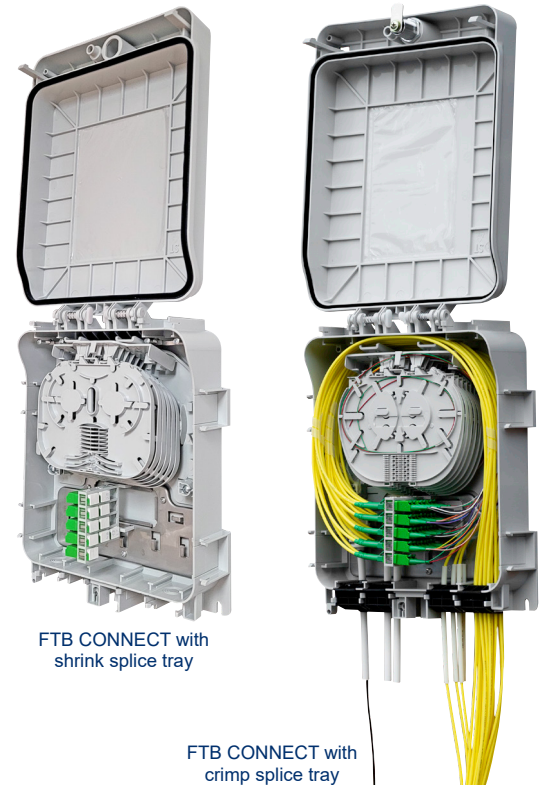

Other features

- IP 55 rated / IP64 (with optional cable glands)
- Ports are numbered for documentation
- Document bag in lid
- IK-08 Shock resistance
- UV protected
- UL 94V-0 flammability protection

Overview

The FTB CONNECT is one of the most versatile fiber termination boxes allowing termination of 72 fibers in a compact design. FTB CONNECT offers expanded installation options with access from all four sides (2 ports on top, 2 ports each side and 4 ports on the bottom) with 10 ports available in total. This allows FTB CONNECT to be installed on wall, pole, or facade. The FTB CONNECT addresses different FTTH topologies and due to its flexibility can accommodate splitter, patch and splice options. FTB CONNECT comes with 6 hinged trays each with 12 crimp/shrink splice holders that can be shared by more than one operator. A safety screw restricts operator B from accessing the fiber trays of operator A.

The lid, when open, can support itself in a couple of different fixed positions facilitating easy fiber routing/management. The lid can also be detached for better access to the box.

The adapter holder will accommodate 13 SC or 26 LC adapters.

FTB CONNECT can be equipped with a lock to prevent unauthorized access.

FTB CONNECT ships with drilling template, mounting hardware, zip ties and several sets of rubber grommets supporting various cable sizes. Optional pole mounting kit is also available. Alternatively, the CONNECT can be used as a pure splice distribution box.

FTB CONNECT - Fiber termination box for wall and pole mounting with access protection



FTB CONNECT using 4 bottom access ports

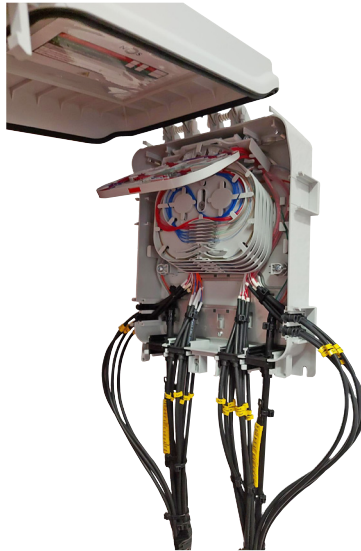

FTB CONNECT using 4 bottom and 2 side access ports. Safety screw restricting operator B from accessing operator A trays

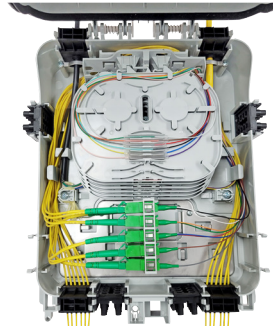

FTB CONNECT - top and bottom access ports

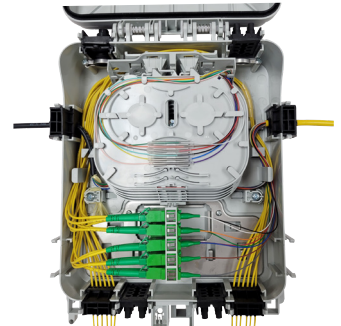

FTB CONNECT - side and bottom access ports

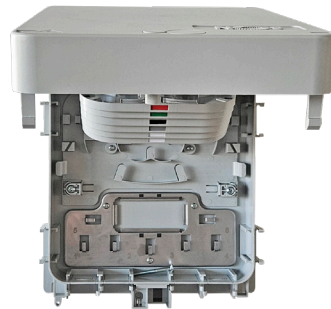

FTB CONNECT lid - self supported at 90 and 130 degrees

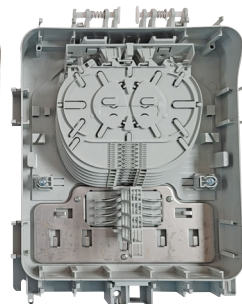

Lid can be detached

FTB CONNECT - Fiber termination box for wall and pole mounting with access protection



Different cable size grommets

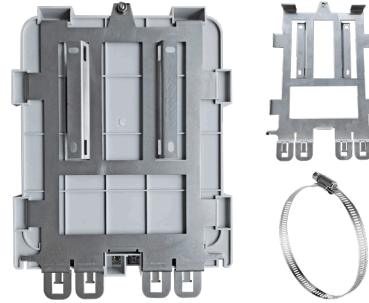

FTB CONNECT (rear view) with pole mounting kit



Adapter holder



Lock

FTB CONNECT device and performance specifications

Parameter	FTB CONNECT	Units	Notes
Number of adapters	13 (optional 16)		
Number of splices	72		
Number of fiber trays	6		
Number of cable insert (top)	2		
Number of cable inserts (sides)	2 x 2		
Number of cable inserts (bottom)	4		
Cable size supported	3-12	mm	
Splitter application	4x PLC in base or 2x PLC in fiber tray		
Lock application	Yes (optional)		
Pole bracket application	Yes (optional)		
Color	RAL 7035		
Dimensions (H x W x D)	295H x 230W x 90D	mm	
IP rating	55/64 with optional cable glands		
Shock resistance	IK-08		
UV protection	Yes		
Flammability (UL 94V-0)	Yes		

FTB CONNECT - Fiber termination box for wall and pole mounting with access protection

Order information

Item code	Description
19015035	FTB CONNECT with crimp splice trays, no adapter holder and no lock
19014707	FTB CONNECT with shrink splice trays, no adapter holder and no lock (NOS)
19014876	GF-HUEP CONNECT with crimp splice trays, clip in PLC holder, 13pc adapter holder and lock
19014806	GF-HUEP CONNECT with crimp splice trays, clip in PLC holder, 13pc adapter holder and no lock
19015036	Lock accessory for FTB CONNECT
19014807	Pole/wall mounting kit accessory for FTB CONNECT

Grommet set included:

- (4x) grommet caps
- (1x) 10 mm OD
- (2x) 7 mm OD
- (1x) 2x7 mm OD
- (2x) 12x5 mm OD
- (2x) 24x3 mm OD

Options:

- Lock
- Safety screw
- Flex-grommet 1x 7-12mm OD
- Shrink holder for 12x shrink with 2x PLC
- Crimp holder for 12x crimp with 2x PLC
- Customer logo engraved
- Sticker / laser printing
- Preassembling available
- Pole mounting set