



# EDFA-R

## Erbium Doped Fibre Amplifier With Redundant Power Supplies

---

Product user manual



**technetix**

---

### Online

Email: [customer.service.vdl@technetix.com](mailto:customer.service.vdl@technetix.com)

Website: [technetix.com](http://technetix.com)

---

**Technetix Group Limited**

Apr/2018 - EU - V2

# EDFA-R

Erbium Doped Fibre Amplifier  
with Redundant Power Supplies

## Product User Manual

## Contents

Safety precautions.....	1
<b>1 The description of the high power EDFA-R.....</b>	<b>2</b>
1.1 Overview .....	2
1.2 Features.....	2
1.3 Models and options .....	3
1.4 Mechanical figures.....	5
<b>2 Operating principle.....</b>	<b>6</b>
2.1 The architecture of the equipment.....	6
<b>3 Specifications.....</b>	<b>7</b>
3.1 Parameters.....	7
3.2 Management interface hardware feature.....	9
3.2.1 RS232 interface.....	9
3.2.2 RJ45 Ethernet interface hardware feature.....	9
3.3 SNMP agent network management system .....	10
3.3.1 Standard compliant.....	10
3.3.2 Main features .....	10
3.3.3 MIB File.....	10
3.4 RS 232 monitoring and terminal management (with RS232 communications).....	10
3.4.1 Hardware condition.....	10
3.4.2 Terminal management.....	13
3.5 TELNET management and SNMP network management.....	14
3.5.1 Hardware requirements.....	14
3.5.2 Network configurations.....	15
3.5.3 TELNET operation.....	16
3.6 Laser safety .....	17
3.6.1 Laser safety precautions.....	17

3.7	Packaging, transport and storage .....	18
3.7.1	Package manifest.....	18
3.7.2	Transportation .....	18
3.7.3	Storage .....	18
<b>4</b>	<b>Equipment operation .....</b>	<b>19</b>
4.1	Panel keys.....	19
4.2	Panel LEDs description.....	19
4.3	Status display menu and instruction.....	19
4.3.1	EDFA-R Front display main menu .....	20
4.3.2	Device state Setting .....	21
4.3.3	Modify the working mode of the equipment.....	22
4.3.4	Change the pump laser state.....	22
4.3.5	Modify the equipment alarm status.....	23
4.3.6	Change the output power.....	23
4.3.7	Select the COM port .....	23
4.3.8	Resetting the device .....	24
4.3.9	View the device serial number.....	24
4.3.10	Network parameter configuration operation .....	24
4.3.11	LCD display translation table.....	25
4.4	The definition of the alarm threshold .....	25

## Safety precautions

Please read the manual first before installing and using this product. The manufacturer is not responsible for any equipment damage, personal injury, or property damage caused by improper operation.



The laser output is a high-power invisible laser. The laser radiation can seriously damage your eyes or skin.



Avoid vibration and collision. The device contains precision optical components that can be damaged.



Please handle carefully and ensure the device is properly grounded. The device is sensitive to static electricity.



Special notice for the optical fibre interface:

1. The optical fibre interface must be clean.
2. When setting up the device insert the output fibre first, then insert the input fibre. When removing optical cables, remove the input first and then the output cable.



Do not open the device. If there are any issues contact a Technetix representative immediately.

## 1 Description of the high power EDFA-R

### 1.1 Overview

The EDFA-R occupies 1RU or 2RU in a 19" sub-rack. The key component of this product is a very reliable multimode pump laser. A unique Automatic Power Control (APC) and Automatic Temperature Control (ATC) circuit ensures stable and reliable output power. The unique optical circuit design ensures excellent optical performance.

The optical circuit is designed specifically for CATV systems. It features a low noise profile to ensure an excellent CNR for analogue systems sensitive to noise. The device also has a high level of spectral flatness across the entire C-band to ensure better CSO. The design includes dual hot-swappable redundant power supplies to reduce the MTBF.

The EDFA-R has an intelligent temperature control system that can reduce power consumption by up to 30%. When the case temperature is over 45 degrees Celsius, a fan will start and continue to operate until the temperature is under 40 degrees Celsius. The technology ensures the thermal stability of the system and increase the fan's lifespan.

It has an intelligent network management system. The device can be controlled through the Ethernet interface, the RS-485 interface, and RS-232 interface. In addition, it can be controlled through SNMP MIB to integrate it with a variety of network management systems.

### 1.2 Features

- Low noise profile: typically less than 4.5 dB (0 dBm input)
- Extremely low CSO distortion: <-70 dBc
- Dual power supplies supporting 220V mixed interpolation with 48V
- High stability and reliability: MTBF 100,000 hours
- Multiple management interfaces: Ethernet, RS-485, and RS-232
- Supports Telnet and standard SNMP network management
- High precision AGC/APC circuit: precision is  $\pm 0.05$  dB
- Intelligent temperature control system: power consumption reduced by up to 30% compared to similar products
- 1RU or 2RU in a 19" sub-rack
- Bellcore GR-1312-CORE compatible

### 1.3 Models and options

#### Model code:

#### EDFA-R-[U-V]-[W]-[X]-[Y]-[Z]

Erbium Doped Fibre Amplifier (Optical Amplifier) with Redundant Power Supplies

#### EDFA-R-I-[U-V]-[W]-[X]-[Y]-[Z]

Erbium Doped Fibre Amplifier (Optical Amplifier) with redundant power supplies and input power threshold range of -10~10 dBm

#### Options:

#### EDFA-R-[U-V]-[W]-[X]-[Y]-[Z]

1RU Height	Number of Output Ports and Output Power
1-13	1 * 13 dBm (13 dBm/per port, 1 port. total 20 mw, 13 dBm), 1RU
1-24	1 * 24 dBm (24 dBm/per port, 1 port. total 250 mw, 24 dBm), 1RU
2-13	2 * 13 dBm (13 dBm/per port, 2 ports. total 40 mw, 16 dBm), 1RU
2-21	2 * 21 dBm (21 dBm/per port, 2 ports. total 250 mw, 24 dBm), 1RU
4-13	4 * 13 dBm (13 dBm/per port, 4 ports. total 80 mw, 19 dBm), 1RU
4-18	4 * 18 dBm (18 dBm/per port, 4 ports. total 250 mw, 24 dBm), 1RU
4-22	4 * 22 dBm (22 dBm/per port, 4 ports. total 634 mw, 28 dBm), 1RU
5-16	5 * 16 dBm (16 dBm/per port, 5 ports. total 200 mw, 23 dBm), 1RU
6-16	6 * 16 dBm (16 dBm/per port, 6 ports. total 240 mw, 24 dBm), 1RU
2RU Height <sup>(1)</sup>	Number of Output Ports and Output Power
8-15	8 * 15 dBm (15 dBm/per port, 8 ports. total 256 mw, 24 dBm), 2RU
8-16	8 * 16 dBm (16 dBm/per port, 8 ports. total 320 mw, 25 dBm), 2RU
8-22	8 * 22 dBm (22 dBm/per port, 8 ports. total 1268 mw, 31 dBm), 2RU
10-22	10 * 22 dBm (22 dBm/per port, 10 ports. total 1585 mw, 32 dBm), 2RU
12-16	12 * 16 dBm (16 dBm/per port, 12 ports. total 480 mw, 27 dBm), 2RU
16-16	16 * 16 dBm (16 dBm/per port, 16 ports. total 640 mw, 28 dBm), 2RU
16-17	16 * 17 dBm (17 dBm/per port, 16 ports. total 802 mw, 29 dBm), 2RU
16-20	16 * 20 dBm (20 dBm/per port, 16 ports. total 1585 mw, 32 dBm), 2RU
20-20	20 * 20 dBm (20 dBm/per port, 20 ports. total 2000 mw, 33 dBm), 2RU
24-8	24 * 8 dBm (8 dBm/per port, 24 ports. total 151 mw, 22 dBm), 2RU
24-16	24 * 16 dBm (16 dBm/per port, 24 ports. total 960 mw, 30 dBm), 2RU
24-18	24 * 18 dBm (18 dBm/per port, 24 ports. total 1585 mw, 32 dBm), 2RU
32-17	32 * 17 dBm (17 dBm/per port, 32 ports. total 1585 mw, 32 dBm), 2RU

<sup>(1)</sup>The 2RU device is used for the types with more than 6 output ports.

EDFA-R-[U-V]-[W]-[X]-[Y]-[Z]

	Optical Connector
S	SC/APC optical connector
E	E2000/APC optical connector
F	FC/APC fit optical connector
L	LC/APC optical connector

EDFA-R-[U-V]-[W]-[X]-[Y]-[Z]

	Network Management
0	None
1	SNMP

EDFA-R-[U-V]-[W]-[X]-[Y]-[Z]

	Power Supply Options (AC = 90~265 Vac, 50~60 Hz; DC = 36~72 Vdc)
1A	SC/APC optical connector
2A	E2000/APC optical connector
1D	FC/APC fit optical connector
2D	LC/APC optical connector
AD	FC/APC fit optical connector

EDFA-R-[U-V]-[W]-[X]-[Y]-[Z]

	Power Cable
EU	Power cable for Europe (not for use in UK)
CN	Power cable for China
CH	Power cable for Switzerland
US	Power cable for USA
UK	Power cable for UK
AU	Power cable for Australia

Accessories

	Power Cable
EDFA-RPSAC	Mains power supply 220 Vac (AC = 90~265 Vac, 50~60 Hz)
EDFA-RPSDC	Mains power supply -48 Vdc (DC = 36~72 Vdc)



## 1.4 Mechanical figures

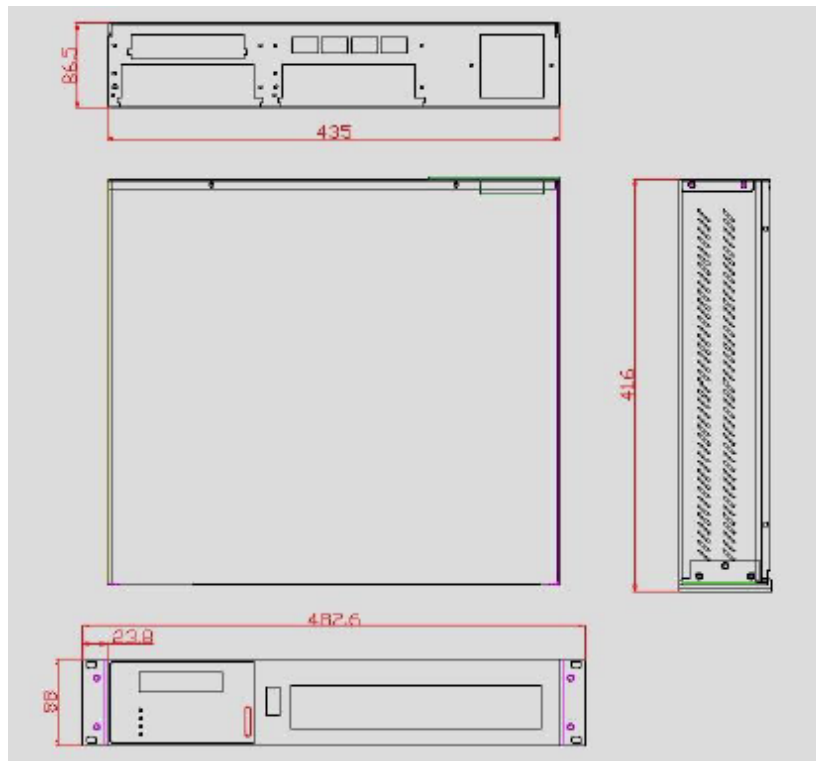

**Case Size:** 483 × 380 × 44 mm (max)

**Net weight:** 6.1 kg

## 2 Operating principle

### 2.1 The architecture of the equipment

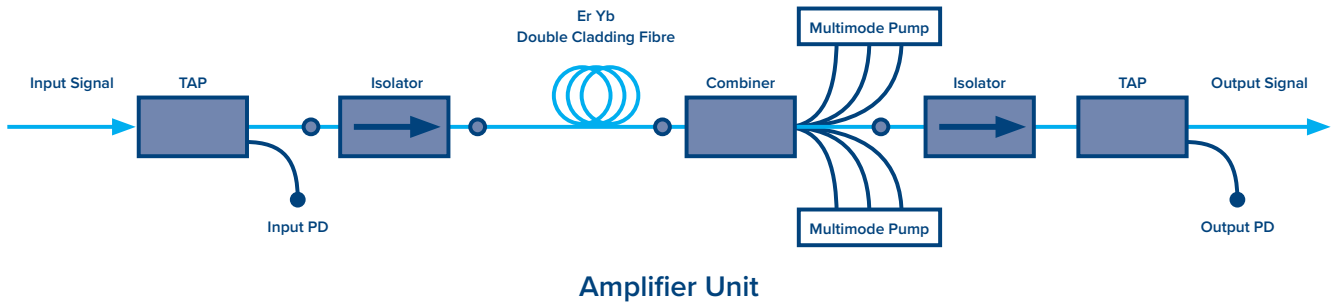

## 3 Specifications

### 3.1 Parameters

#### Optical performance

Parameters	Symbol	Min	Typ	Max	Unit	Notes
Optical wavelength	$\lambda_c$	1530	1550	1565	Nm	
Saturated output power	Posat	13	-	32	dBm	1
Input power	Pi	-3	-	+10	dBm	2
Gain	G	-	20	-	dB	
Noise level	NF	-	4.5	-	dB	3
Output power stability	$\Delta P_o$	-	$\pm 0.05$	$\pm 0.1$	dB	
Input isolation	ISOi	30	-	-	dB	
Output isolation	ISOo	30	-	-	dB	
Input pump leakage	PLi	-	-	-35	dBm	
Output pump leakage	PLo	-	-	-45	dBm	
Return loss	RL	-	-	-45	dB	
Polarization dependent gain	PDG	-	-	0.3	dB	
PMD	PMD	-	-	0.5	ps	
Optical connector	SC/APC, E2000/APC, FC/APC, LC/APC					

#### Electrical performance

Parameters	Symbol	Min	Typ	Max	Unit	Notes
Power supply	Vps	85/170	220	132/264	VAC	4
Power consumption	P	-	-	18	W	5









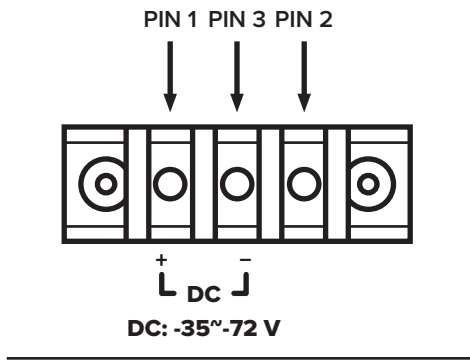

#### General

Parameters	Symbol	Min	Typ	Max	Unit	Notes
Operation temperature	Tw	-5	-	60	°C	
Storage temperature	Ts	-40	-	0	°C	
Humidity (no condensation)	Pi	10	-	90	%	
Dimensions (H × W × D)	44 × 483 × 220 mm					
Weight	6.0 kg					









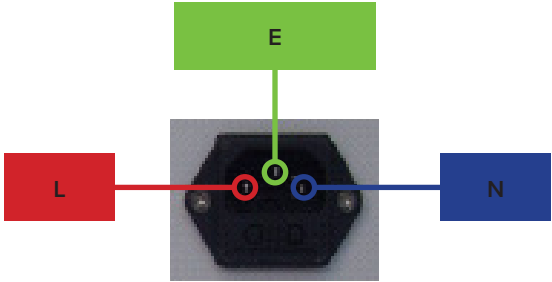

#### Notes

1	Customer optional
2	Standard input power range, only for EDFA-R-[U-V]-[W]-[X]-[Y]-[Z]
3	Test at 0 dBm input power
4	220 Vac, -48 Vdc and 220 Vac / -48 Vdc are optional
5	The actual power consumption is relative to output power and operation environment temperature

**-48 VDC interface definition:**

	<table border="0"> <tr> <td>PIN 1 = Red</td> <td></td> <td>PGND</td> </tr> <tr> <td>PIN 2 = Yellow</td> <td></td> <td>CGND</td> </tr> <tr> <td>PIN 3 = Green</td> <td></td> <td>-48 V</td> </tr> </table> <p><b>-48 VDC Interface</b>          PGND: power ground          CGND: chassis ground          -48 V: power -48 V</p>	PIN 1 = Red		PGND	PIN 2 = Yellow		CGND	PIN 3 = Green		-48 V
PIN 1 = Red		PGND								
PIN 2 = Yellow		CGND								
PIN 3 = Green		-48 V								

**220 VAC interface definition:**

	<table border="0"> <tr> <td>PIN 1 = Red</td> <td></td> <td>L</td> </tr> <tr> <td>PIN 2 = Yellow Green</td> <td></td> <td>E</td> </tr> <tr> <td>PIN 3 = Blue</td> <td></td> <td>N</td> </tr> </table> <p><b>220 VAC interface</b>          L: live          N: neutral          E: earth</p>	PIN 1 = Red		L	PIN 2 = Yellow Green		E	PIN 3 = Blue		N
PIN 1 = Red		L								
PIN 2 = Yellow Green		E								
PIN 3 = Blue		N								

## 3.2 Management interface hardware feature

### 3.2.1 RS232 interface

#### General features

Interface type: DB-9 (female)

Baud rate: 9600 bit/s

Data Bit: 8

Parity: Off

Stop bit: 1

Data flow control: Off

#### RS232 interface specification

RS232 Interface rule for example Table 3.1

Table 3.1: RS232 interface feature

Transmission Line	PIN 2 (RXD) PIN 3 (TXD) PIN 5 (GND)
RXD, TXD Logic1 (MARK) Voltage Amplitude	-3~15 V
RXD, TXD Logic0 (SPACE) Voltage Amplitude	3~15 V
The Max. Transmission Distance	15 m
Driver Load Capacitance	<2500 pf

#### RS232 interface specification

RS232 interface is fully compliant with standard RS232 interface specifications to ensure distortion is less than 4%.

### 3.2.2 RJ45 Ethernet interface hardware feature

#### RJ45 Ethernet interface specifications

Table 3.1: RS232 interface feature

Interface type	RJ45
Speed rate	10 Mbit/s

### 3.3 SNMP AGENT network management system

The SNMPv1 and SNMPv2 are supported by the firmware. It can be accessed by the standard SNMP network management tools.

Through network management software, detailed parameters can be viewed including performance parameters, power information, device temperatures, and history record.

#### 3.3.1 Standard compliant

1. Compliant with SNMP version 1
2. Compliant with SNMP version 2

#### 3.3.2 Main features

1. Fault monitoring: notifications when there is an error or abnormality in the network
2. Configuration management: configuration parameters can be set through the configuration interface
3. Performance management: the device can automatically collect statistical data for the to assess system performance

#### 3.3.3 MIB file

Standard MIB tree (Figure: 3-1).

Please contact Technetix' technical support for the full list of MIB parameters

### 3.4 RS 232 monitoring and terminal management (with RS232 communications)

The equipment can be accessed from a PC by a female to female DB-9 connection and the communication distance must not exceed 12 m.

#### 3.4.1 Hardware condition

Transmission line	Parameter	Quantity
RS232 cross line	DB-9 (female)	1
PC	Serial port software, with DB-9 male COM port, Windows system	1
Amplifier	2U amplifier with serial port communication	1

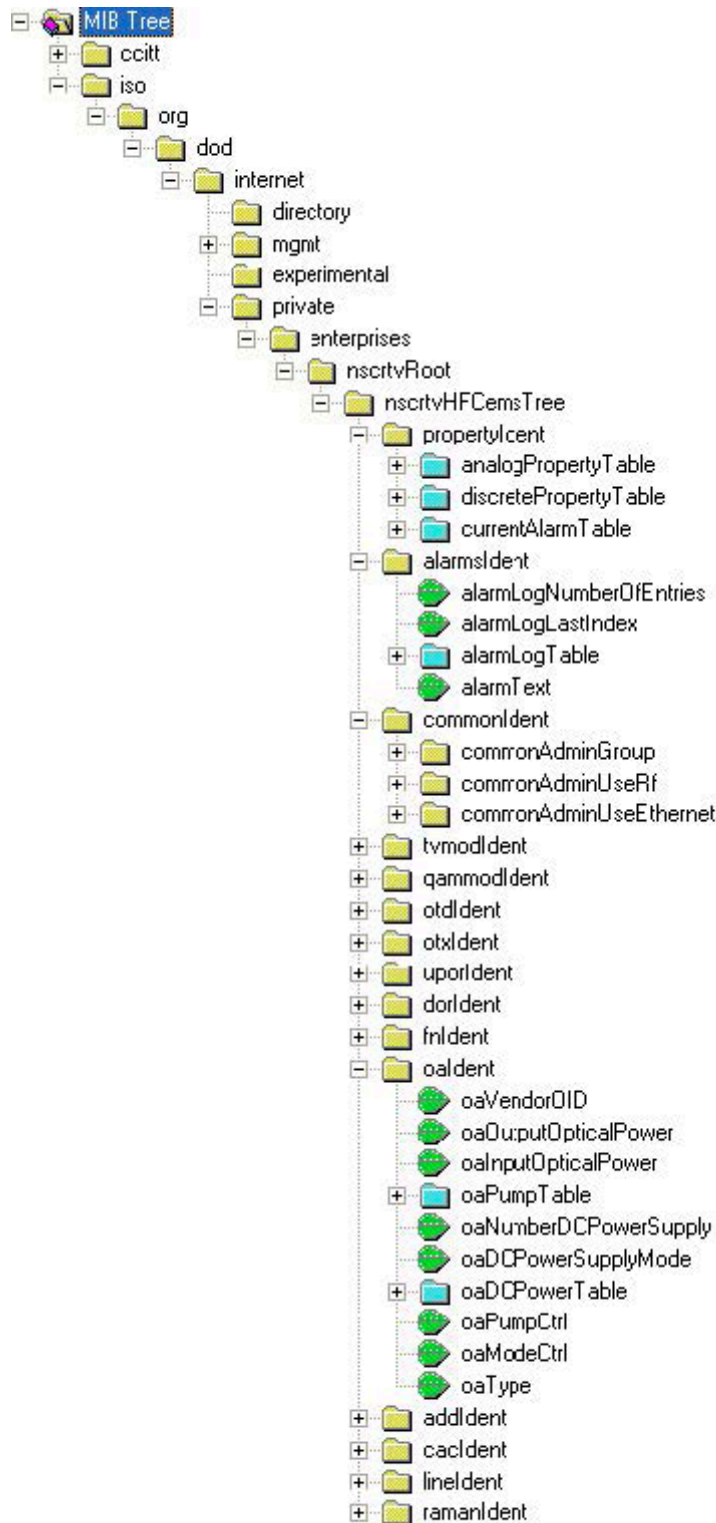

Figure 3-1 standard MIB tree

**DB-9 cross line connectivity**

DB-9 female 1	DB-9 female 2	Connectivity
PIN2	PIN3	Interconnected
PIN3	PIN2	Interconnected
PIN5	PIN5	Interconnected
PIN1, PIN4, PIN6 PIN7, PIN8, PIN9	PIN1, PIN4, PIN6 PIN7, PIN8, PIN9	Interconnected or disconnect

**Crosses line connectivity figure:**

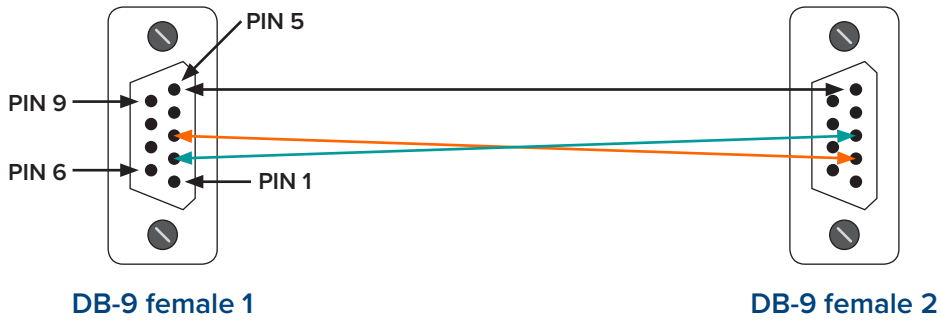

Figure 3-2 DB-9 cross connection layout



### 3.4.2 Terminal management

Connect the equipment and PC by a serial cable and power on the equipment, and then start the terminal software according to the parameters of the selected serial port (9600 bps, 8 bit data, 1 bit stop, parity and flow control off).

Once a terminal connection is successfully established, please input the user name 'admin' and the password '12345'.

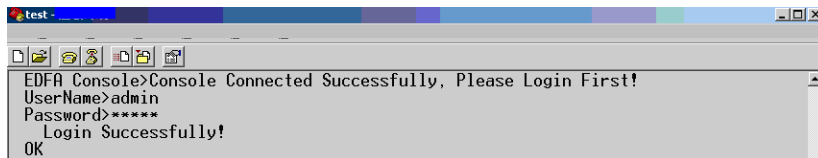

After successfully logging in, type '?' or 'help', then press the [Enter] key to retrieve a list of supported commands.

### Serial port console commands

Command	Syntax	Command explanation	Additional information
Exit	N/A	Exit serial console mode	This command exits serial console mode. The [Enter] key must be pressed 3 times before another entering command.
Enter	N/A	In application mode, pressing [Enter] key 3 times to use console mode	-
Admin	N/A	The username is ADMIN when logging in.	The unit only supports one user account
Password	N/A	When the terminal displays a "", the user is bring prompted for a password	The default admin password is '12345'
Logout	N/A	Logs the current user out	-
Help	N/A	Displays the help interface	-
?	N/A	Displays the help interface	-
ver	N/A	Displays the equipment version	-
Set	IP [IP Address]	Used to set an IP address	-
Show	N/A	Displays the equipment configuration information	-
Set	Logo xxxxxx	Set a string of text to act as a logo	The content of logo text must be less than 20 characters and quotation marks must be used

### 3.5 TELNET management and SNMP network management

#### 3.5.1 Hardware requirements

Item	Parameter	Quantity
Network line	Crossover cable, straight-through cable	1
PC	Network management software and a Telnet client should be installed.	1
Amplifier	2U Amplifier, with Ethernet port	1
Network	LAN, Internet	1

The corresponding Figure 3-3 of network cable:

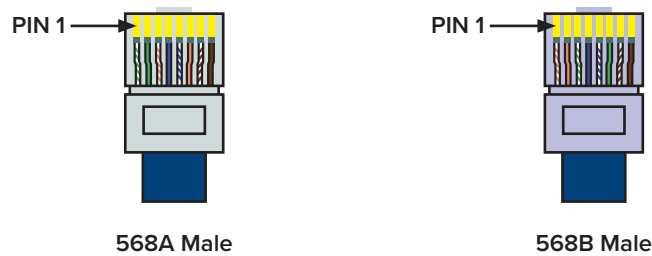

**568A Male:**

Orange and White—1, Orange—2, Green and White—3, Blue—4, Blue and White—5, Green—6, Brown and White—7, Brown—8,

**568B Male:**

Green and White—1, Green—2, Orange and White—3, Blue—4, Blue and White—5, Orange—6, Brown and White—7, Brown—8,

**Cross lines:**

Two heads the center line of a different order, namely: one for the T568A, one for the T568B;



**Direct line:**

Two heads the center line of the same order, such as the two are T568B stander;



Figure 3-3 Network line connection figure

### 3.5.2 Network configuration

The steps for directly connecting the equipment with a PC:

1. Set the IP address through the front panel
2. Connect the RJ-45 port to a PC Ethernet port using a crossover Ethernet cable

The steps for connecting equipment with a PC through a network:

1. Set the IP address by front panel
2. Connect the RJ-45 port on equipment to a switch, router, or hub that also connects to a PC

The steps for connecting equipment with PC through network:

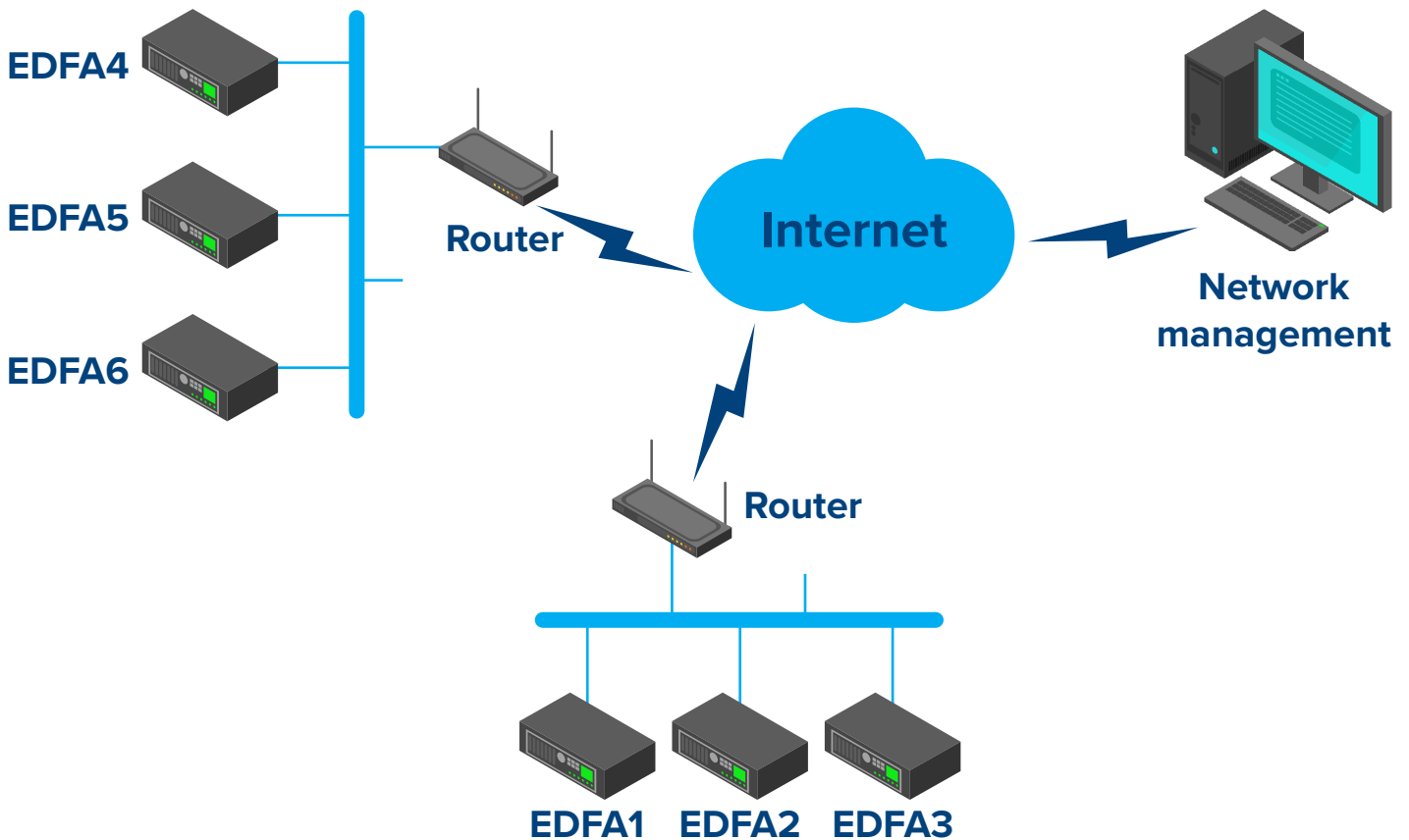
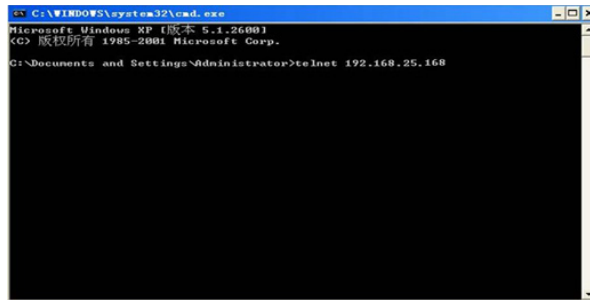

Figure 3-4 Network Connect

### 3.5.3 TELNET operation

1. The EDFA-R supports TELNET management.

To access the EDFA-R's TELNET server from Windows, open a DOS command prompt and type 'Telnet 192.168.25.168'. Press the [Enter] key and the computer should connect with the equipment. In this example, '192.168.25.168' is the IP address of the equipment.



2. After successfully connecting, the user name and password is required

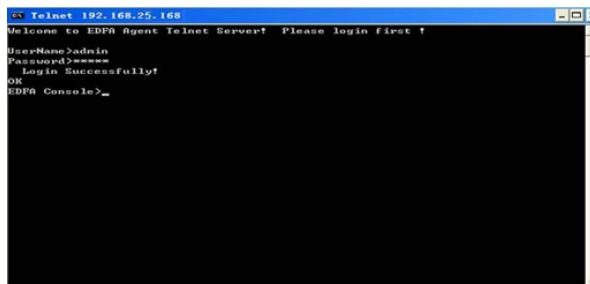

Compared with traditional TELNET clients, the command prompt TELNET client that comes with Microsoft Windows has some minor differences:

- The **'quit'** command is used to exit a session
- Only one TELNET window session is allowed to the equipment at the same time
- The TELNET session will disconnect automatically if it is idle for 5 minutes. The **'Telnet [IP Address]'** command should be used to reconnect to the equipment
- After successful connecting, the user can exit the TELNET session. The **'[Control]+[X]**, **'[Control]+[D]**, and the **'[Control]+[C]'** hotkeys are supported
- If the TELNET window closes abnormally (such as a computer crash, close the command window directly by clicking **'X'** in the top right of the window. Reconnecting to the equipment immediately will fail. You must wait 5 minutes for the previous session to timeout.

If the EDFA-R restarts abnormally, but the TELNET command line window was not closed, you must force the window to close and wait for 5 minutes to reconnect.

### 3.6 Laser safety

This product has a category 3B laser. The output power is between 1 mW ~ 200 mW. Direct laser exposure will damage human skin and eyes.



Figure 3-5 Laser alarm and description mark

#### 3.6.1 Laser safety precautions

The optical fibre adapter and optical jumper have a safety cover. **DO NOT** remove the cover before the equipment is connected to prevent any direct laser exposure. The cover should be removed and the adapter connected to the equipment before it is powered on.

## 3.7 Packaging, transport and storage

### 3.7.1 Package manifest

The product package includes the performance test data, equipment specifications, power cable, and the amplifier. Plastic film is used to cover and protect the package when it is transported and stored.

### 3.7.2 Transportation

1. When transporting the product, it is recommended to cover the equipment packages with canvas to prevent damage from moisture or condensation
2. Stack the products in a way that prevents them from moving during shipment
3. It is recommended that you do not ship the equipment with flammable, explosive, or corrosive products
4. Equipment must be carefully handled. Never turn the equipment upside-down.

### 3.7.3 Storage

1. When storing the equipment, place it in its original packaging
2. The environment should be kept clean and dry. The temperature should be between -20 degrees Celsius ~ +70 degrees Celsius. The humidity should be kept between 10%~90%
3. The package should be placed on a rack more than 30 cm from the ground and more than 40 cm away from walls.

## 4 Equipment operation

### 4.1 Panel keys

Definition	Key	Description
▲	Scroll up	This key is used to change the menu or move the selector on the panel up
▼	Scroll down	This key is used to change the menu or move the selector on the panel down
▶	Scroll right	This key is used to change the menu or move the selector on the panel right
◀	Scroll left	This key is used to change the menu or move the selector on the panel left
OK	Enter	This key is used to select menu entries, enter into submenus, and confirm the changes
ESC	Esc	This key is used to exit the current menu or to exit the a submenu

### 4.2 Panel LEDs description

Definition	Description
<b>Power 1</b>	Power 1 indicated the status of power module 1. Red and yellow colours indicate a problem. A green colour indicates a normal state.
<b>Power 2</b>	Power 2 indicated the status of power module 2. Red and yellow colours indicate a problem. A green colour indicates a normal state
<b>Alarm</b>	General warning indicator. This LED is used to indicate non-optical problems with the EDFA-R unit. Red and yellow colours indicate a problem. A green colour indicates a normal state.
<b>Signal</b>	Optical activity indicator. Red and yellow colours indicate a problem with either input or output optical signals. A green colour indicates a normal state.

#### Notice:

When the equipment is experiencing problems, the indicator LEDs will be yellow or red. The red LED indicates a critical warning. The warning should be addressed by an operator immediately resolve the issue. The yellow led indicates a minor alert and the equipment may still be functioning. The alert should be addressed by the operator so the problem does not escalate.

### 4.3 Status display menu and instruction

Check the voltage and confirmed unit is properly grounded.

The dual power supply is -48 VDC, a mix of -48 VDC and 220 VAC, or dual 220 VAC. The EDFA-R will be in a stable state 30 minutes after powering the unit on.

After powering the device, the screen shows the company and model information. After 3 seconds, the device parameter menu will be showed.

### 4.3.1 EDFA-R's Front display main menu

The display menu will change when the ▼ key is pressed.

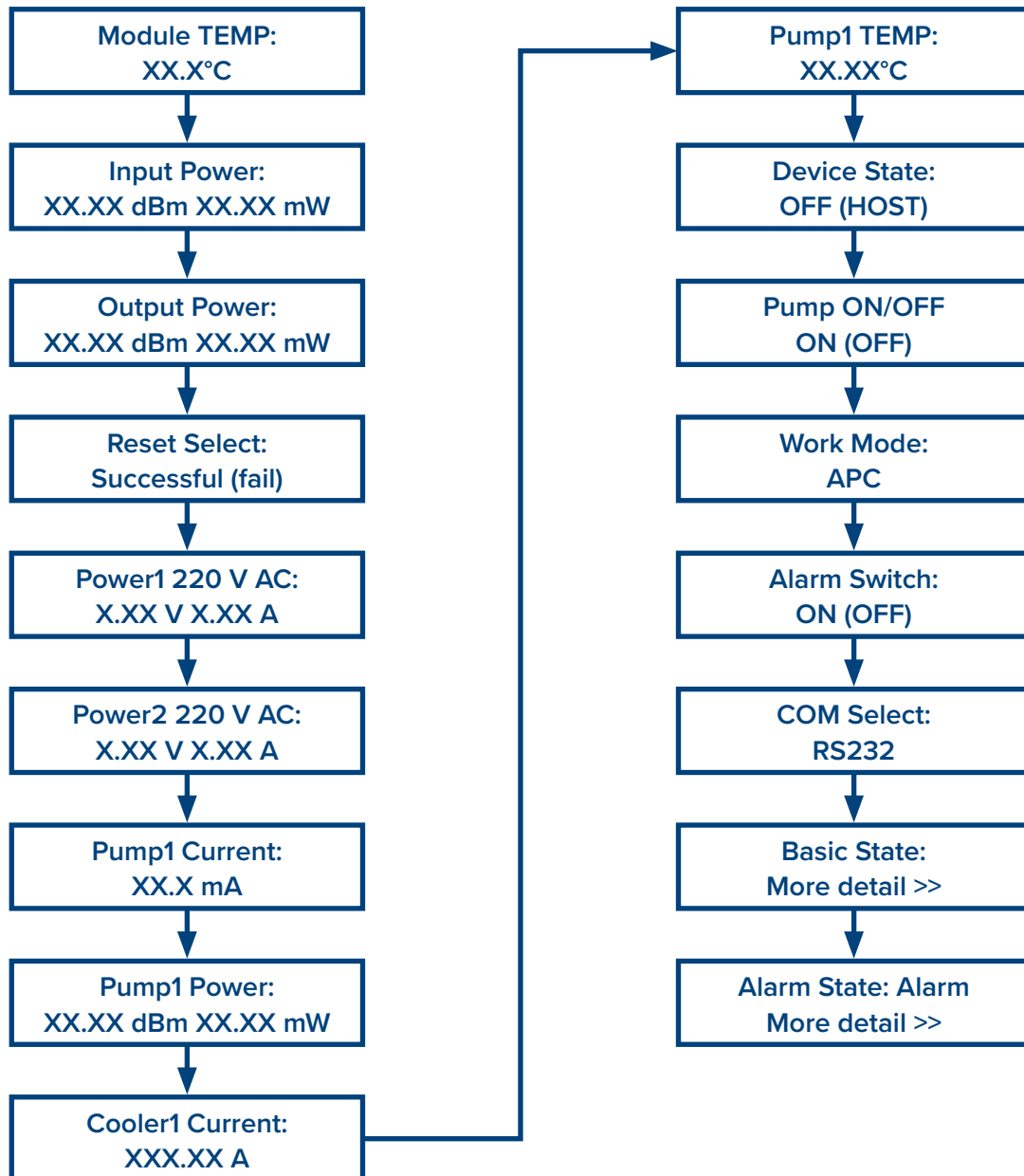

**Notice:**

If there is one pump laser, the menu will display the pump state information, if two pump lasers exist, pump information for both will be displayed.



#### 4.3.2 Device state setting

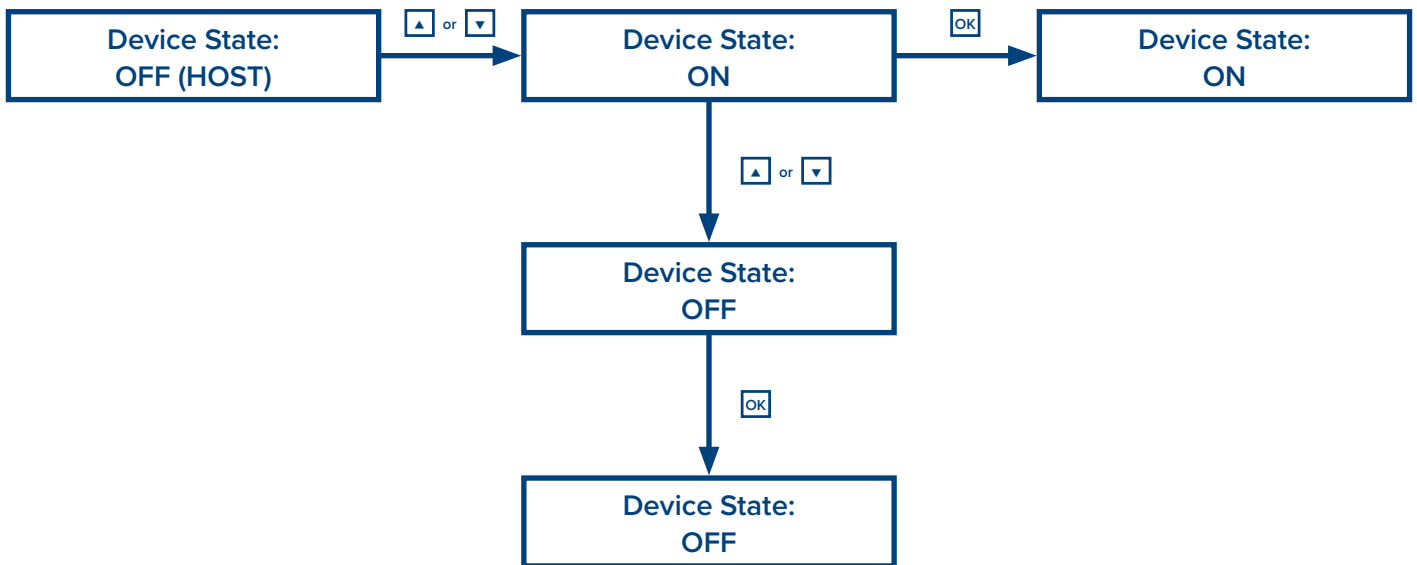

'Device State' setting is to open or close the function of redundancy. The default setting of 'Device State' is OFF.

**Notice:**

Make sure the device state is '**OFF**' if the EDFA-R amplifier doesn't work at redundancy mode (in redundancy mode, 2 EDFA-R amplifiers are linked with cables). **Otherwise, the EDFA-R amplifier will fail to restart the pump when it is repowered or reset.**

#### 4.3.3 Modify the working mode of the equipment

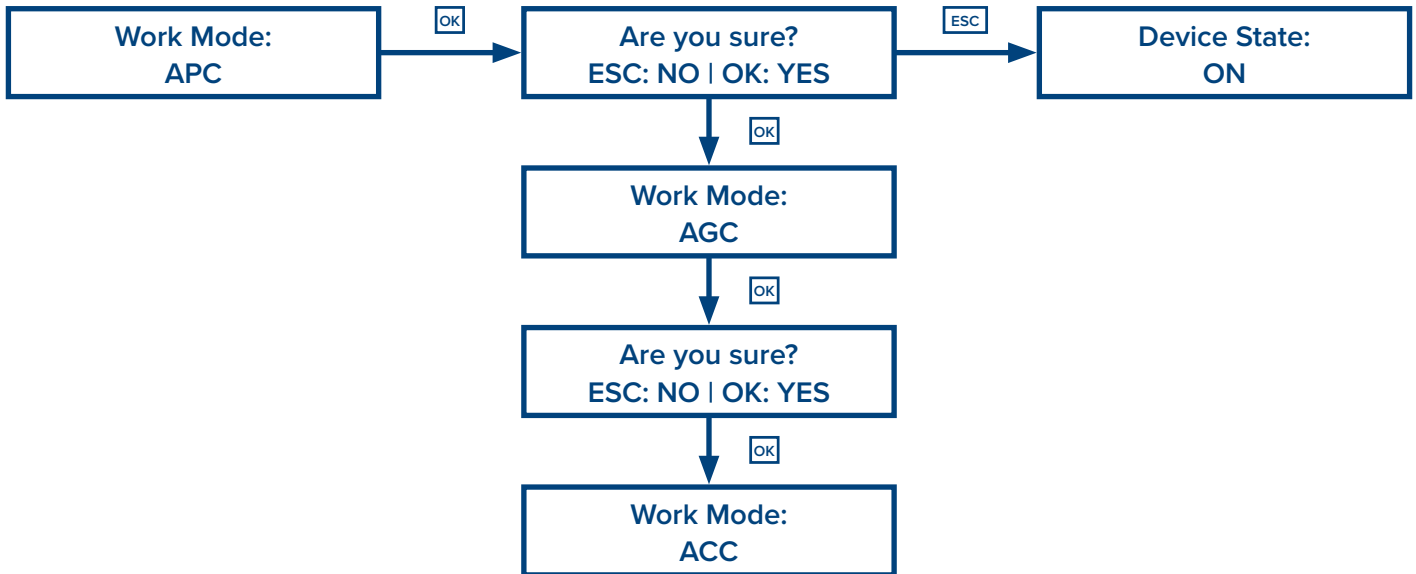

**Notice:**

The equipment is already calibrated. There are no calibration settings for the optical output in different work modes. The output power may be incorrect if the work mode is changed.

**DO NOT** change the work mode without checking with a Technetix representative.

#### 4.3.4 Change the pump laser state

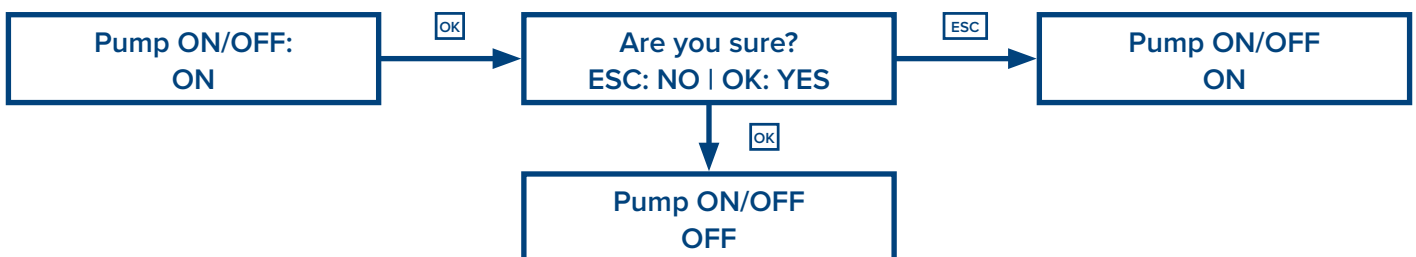

**Notice:**

The equipment may not function correctly if pump laser state is changed.

#### 4.3.5 Modify the equipment alarm status

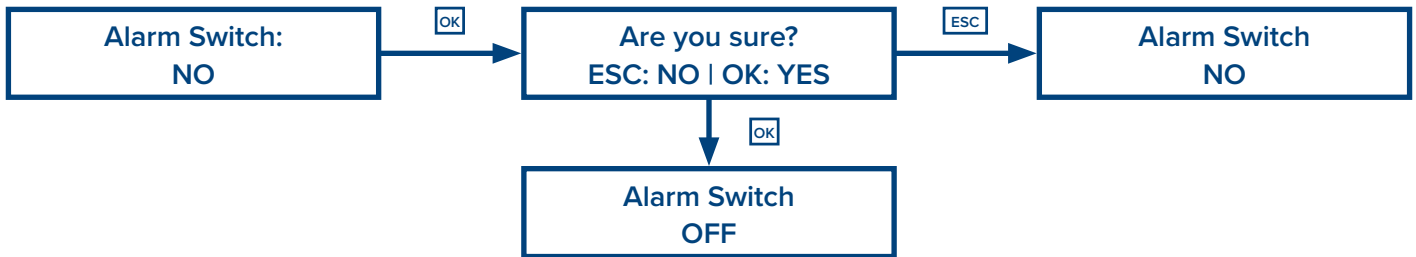

An alarm will not indicate any problems if it is disabled.

#### 4.3.6 Change the output power

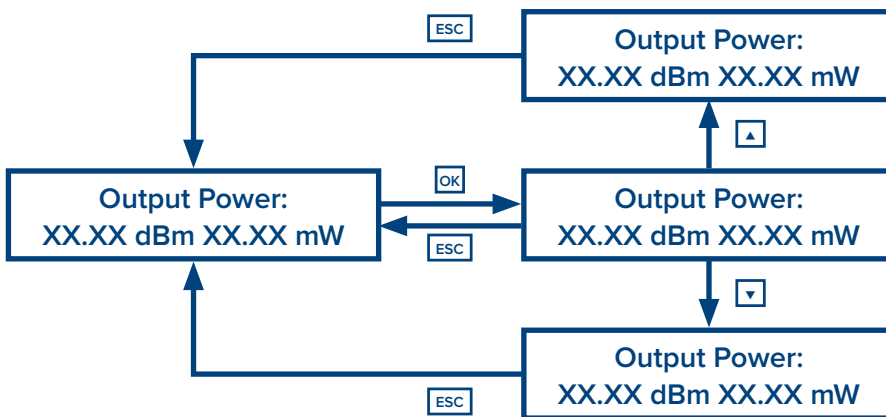

#### 4.3.7 Select the COM port

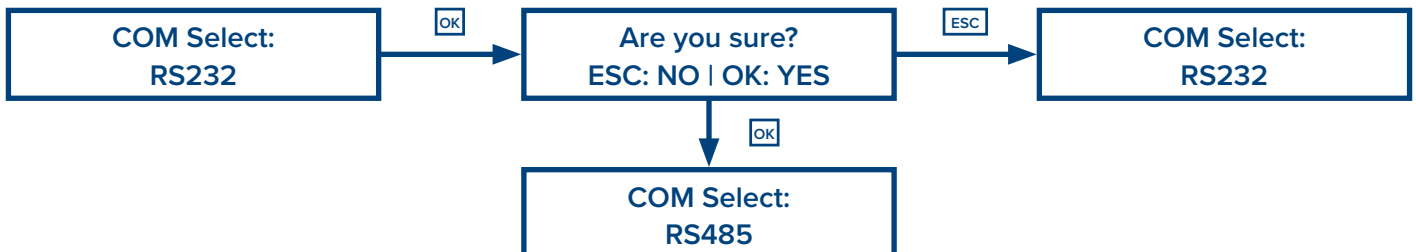

Changes the serial port's communication port.

#### 4.3.8 Resetting the device



When the network control card is swapped or changed, the device will need to be reset. It is recommended that the default settings are restored when changing the network control card.

#### 4.3.9 View the device's serial number



#### 4.3.10 Network parameter configuration operation

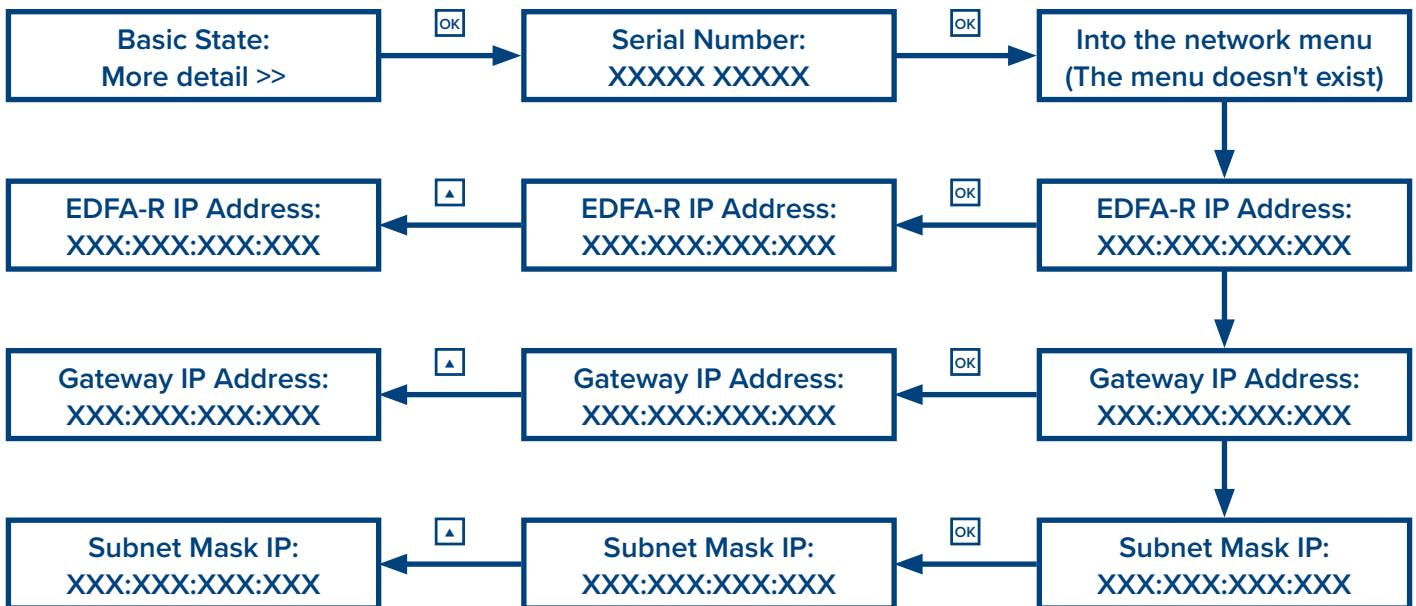

#### Modify IP address:

Select the EDFA-R IP address menu, then press the 'OK' key. The next menu appears and there will be a flashing cursor which can use the up or down arrow keys to select a number 0 through 9. The left and right navigation keys are used to move the cursor to the correct position to modify network configuration under the customer requirements.

#### Notice:

Set and confirm the IP address, the subnet mask, and the default gateway address. Consult your network administrator for more information.

#### 4.3.11 LCD display translation table

Display item	Translation	Display item	Translation
Serial No	The serial number of the equipment	Pump 1 TEMP MAX	The maximum temperature of the pump 1 alarm threshold
EDFA-R Model	Equipment model information	Pump 1 TEMP M in	The minimum temperature of the pump 1 alarm threshold
Voltage	Operating voltage	Time of Day	Equipment working time
Working Temp	Operating temperature	+5V Power	Voltage of the equipment
EDFA-R MAC Address	MAC address	Module TEMP	Module temperature
EDFA-R IP Address	IP address	In Power	Input power
Gateway IP Address	IP Gateway address	Out Power	Output power
Subnet Mask IP	The subnet mask	Pump 1 TEMP	Pump 1 temperature
EDFA-R PORT Number	Reserved for factory	Pump 1 Current	Pump 1 current
Module TEMP MAX	The maximum equipment temperature alarm threshold	Pump 1 Power	Pump 1 power
Module TEMP MIN	The minimum equipment temperature alarm threshold	Cooler 1 Current	Pump 1 cooling current
Pump Laser Threshold	Threshold to shutdown the pump	Reset Select	Reset key
In Power MAX	The maximum input power alarm threshold	Power 1 220VAC	The supplied voltage of from power supply 1
In Power MIN	The minimum input power alarm threshold	Power 2 220VAC	The supplied voltage of from power supply 1
Out Power MAX	The maximum output power alarm threshold	Pump ON / OFF	Pump ON/OFF
Out Power MIN	The minimum output power alarm threshold	Work Mode	Working mode
Pump 1 Current Max	The maximum current of pump 1's alarm threshold	Alarm Switch	Alarm Enable Switch
Pump 1 Current Min	The minimum current of pump 1's alarm threshold	Com Select	Serial Mode
Pump 1 Power Max	The maximum power of pump 1's alarm threshold	Basic State	Basic information item
Pump 1 Power Min	The minimum power of pump 1's alarm threshold	Fan speed monitor	

#### 4.4 The definition of the alarm threshold

When the alarm values are beyond or below the threshold set, the corresponding alarms will be indicated. Corresponding LEDs are change according to the type of the alarm. In addition, network management software can also show alarms.

There are four level alarms: Hi-Hi, Hi, Lo, and Lo-Lo.

Alarm Level	Description	LED indicator
Hi-Hi Threshold	When an alarm variable is higher than the threshold, a Hi-Hi alarm is used to indicate the unit is not functioning correctly.	The alarm LED will flash red
Hi Threshold	When an alarm variable is higher than the threshold, a Hi alarm is used to indicate the unit is not functioning correctly.	The alarm LED will flash yellow
Normal	When the value of a physical variables is between the Hi and Lo thresholds, the device is functioning normally	The green LED will flash
Lo Threshold	When an alarm variable is higher than the threshold, a Lo alarm is used to indicate the unit is not functioning correctly.	The alarm LED will flash yellow
Lo-Lo Threshold	When an alarm variable is higher than the threshold, a Lo-Lo alarm is used to indicate the unit is not functioning correctly.	The alarm LED will flash red
Hysteresis Value	When the equipment has an alarm, if the alarm variables revert to the normal operating range, the alarm will not turn off immediately unless the value is lower than the difference of the threshold and the hysteresis value. For example the normal temperature scope is -5 to 70 degrees Celsius, the Hi-Hi threshold is 70 and the hysteresis value is 1. If the temperature of the equipment is up to 75 degrees Celsius, then the Hi-Hi temperature alarm indicates the temperature has exceeded the Hi-Hi threshold of 70 degrees Celsius.	

The following table shows the various parameter ranges of the device. The parameters may vary depending on the application of the device. The specific values for the device can be viewed from the associated network management software and the following parameter values are only for reference.

Description		Hi-Hi Threshold	Hi Threshold	Lo-Threshold	Lo-Lo Threshold	Hysteresis Value
Input power (unit: dBm)	X <sup>Y</sup> (X,Y is the input power range)	Y+2	Y+1	X-1	X-2	0.1
Output power (unit: dBm)	X <sup>Y</sup> (X,Y is the output power range)	Y+2	Y+1	X-1	X-2	0.1
Single	Voltage (V)	6	5.5	4.5	4	0.1
Dual supply	Voltage 1 (V)	6	5.5	4.5	4	0.1
	Voltage 2 (V)	6	5.5	4.5	4	0.1
	Current 1 (A)	7	5	-1	-2	0.1
	Current 1 (A)	7	5	-1	-2	0.1
Equipment temperature (degrees Celsius)		80	75	-5	-10	0.1
Pump temperature (unit degrees Celsius)		35	30	20	15	0.1
Cooling current (unit mA)		3000	2500	-2500	-3000	0.1
Pump working current (unit mA)		1500	1400	10	5	0.1

**technetix**

---